

Afin de déterminer la housse la mieux adaptée à votre moto ou à votre scooter, bien prendre les 2 mesures suivantes :









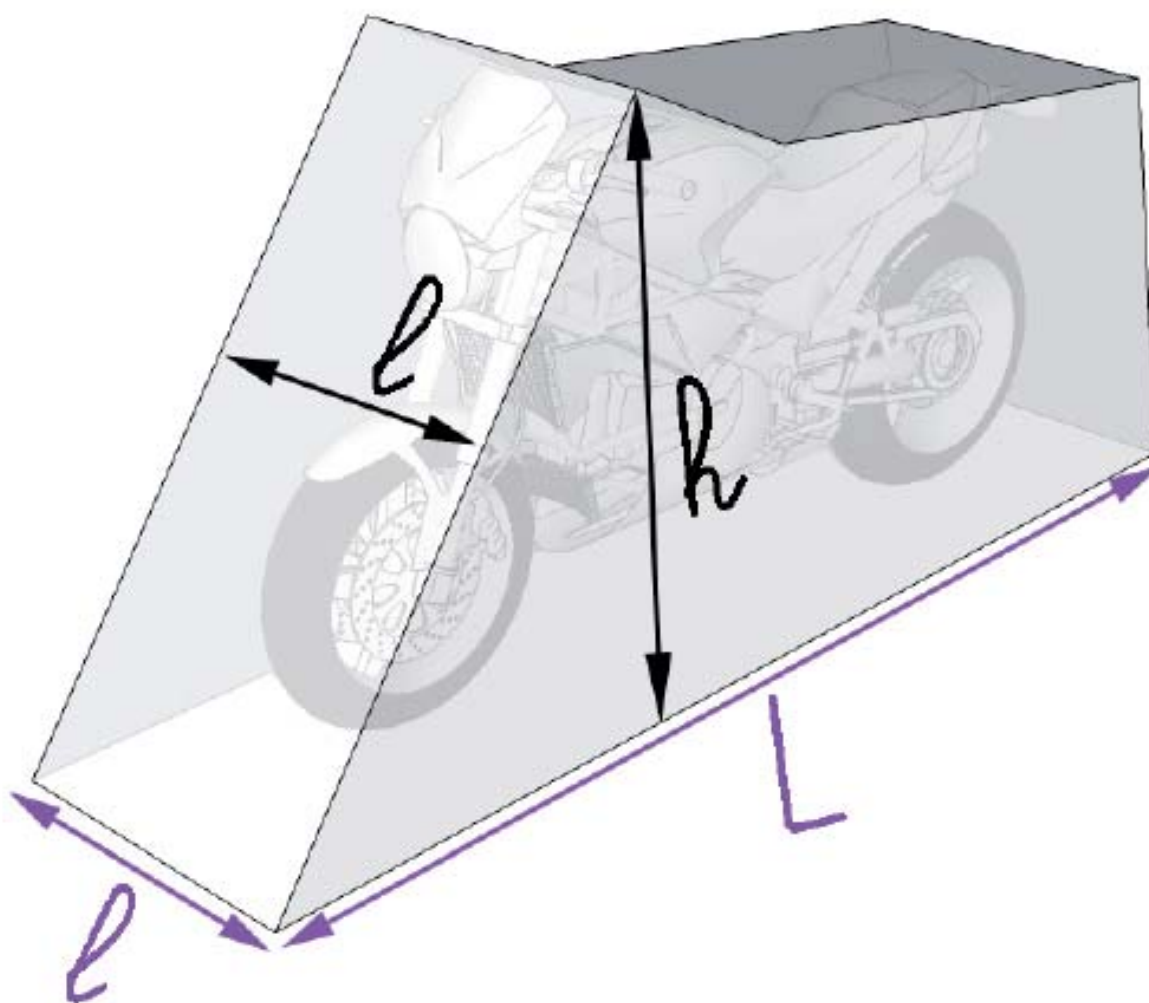

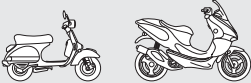
MESURE 1 : Périmètre inférieur





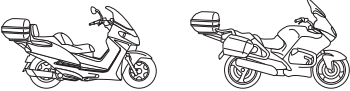
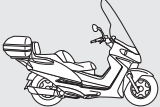













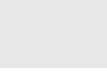
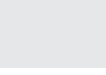

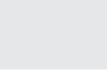
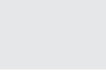

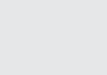
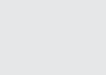
$$(\ell + L) \times 2$$

MESURE 2 :

$$(h \times 2) + \ell$$

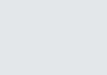

DIMENSIONS MOTO #2		<i>Dims. maxi en cm</i>		
Modèle		Périmètre inférieur	H x 2 + l	Taille
		470	270	S
		530	295	SS
		520	330	S1
		520	380	S2
		470	380	S3
		570	290	M
		560	310	MS
		645	340	M1
		645	390	M2
 <i>Suzuki Burgman 650 avec bulle haute et top-case</i>		645	390	M3
		640	350	L
		680	372	XL
		Base: 240 x 200cm Haut. moto: 140cm Haut. sidecar: 100cm		SC

DIMENSIONS MOTO #1		<i>Dims. maxi en cm</i>				
Modèle		Périmètre inférieur	H x 2 + l	Taille		
		420	274	A		
		440	326	A1		
	<i>Modèles A-B-C avec bulle haute</i>	460	370	A3		
		440	270	B		
	<i>Modèles A-B-C avec top-case</i>	520	326	B1		
	<i>Modèles A-B-C avec bulle haute et top-case</i>	520	370	B2		
		380	274	C		
			530	344	D	
		530	295	DS		
			560	344	E	
		560	310	ES		
			<i>Modèles D-E avec top-case</i>	645	344	E1
			<i>Modèles D-E avec top-case et bulle haute</i>	645	390	E2
		<i>Suzuki Burgman 650 avec bulle haute et top-case</i>	645	390	E3	
		520	344	F		
		600	350	G		
		680	350	H		
		Base: 240 x 200cm Haut. moto: 140cm Haut. sidecar: 100cm		SC		