

A

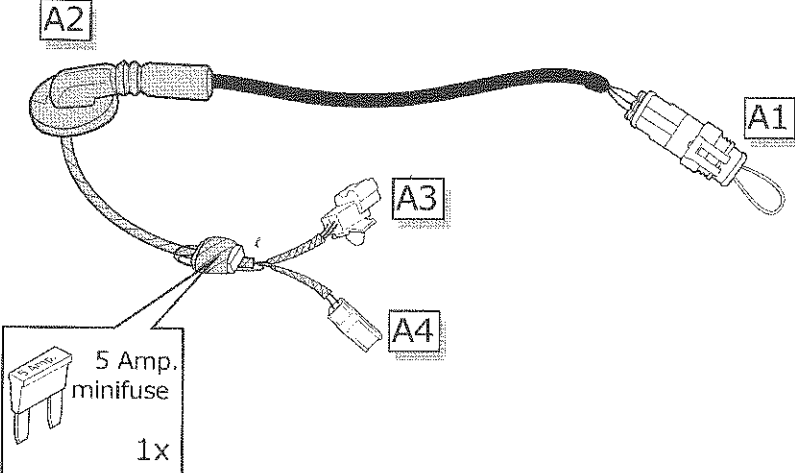

1x

B

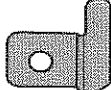

1x

C

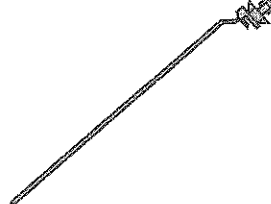

1x

D

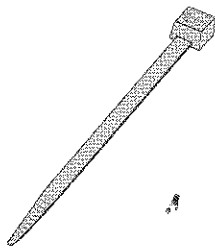

4x

E

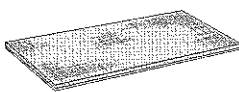

1x

F



1x

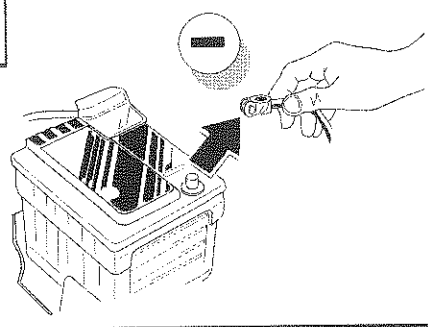
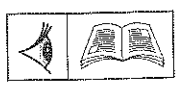

1

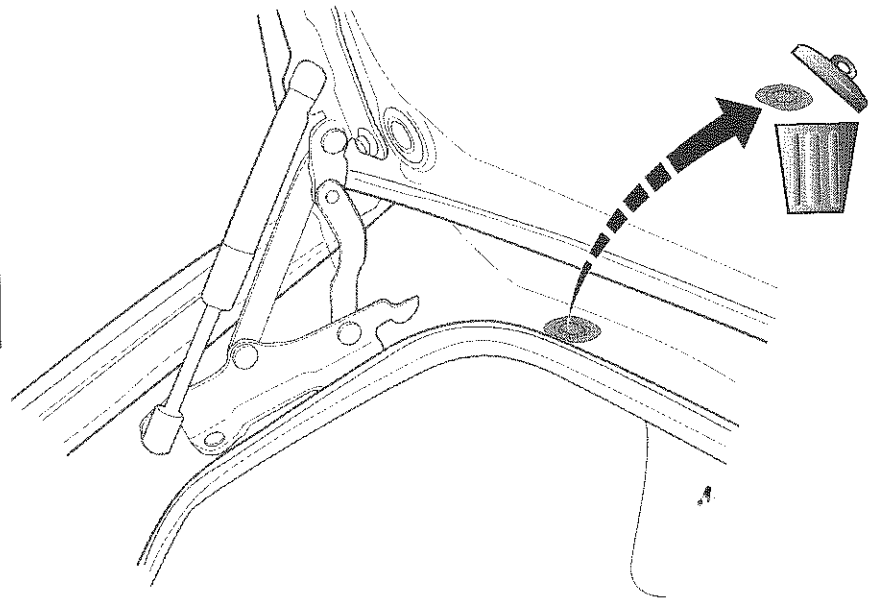
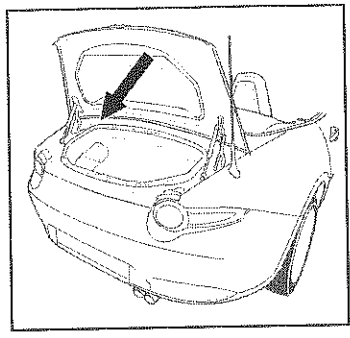

2

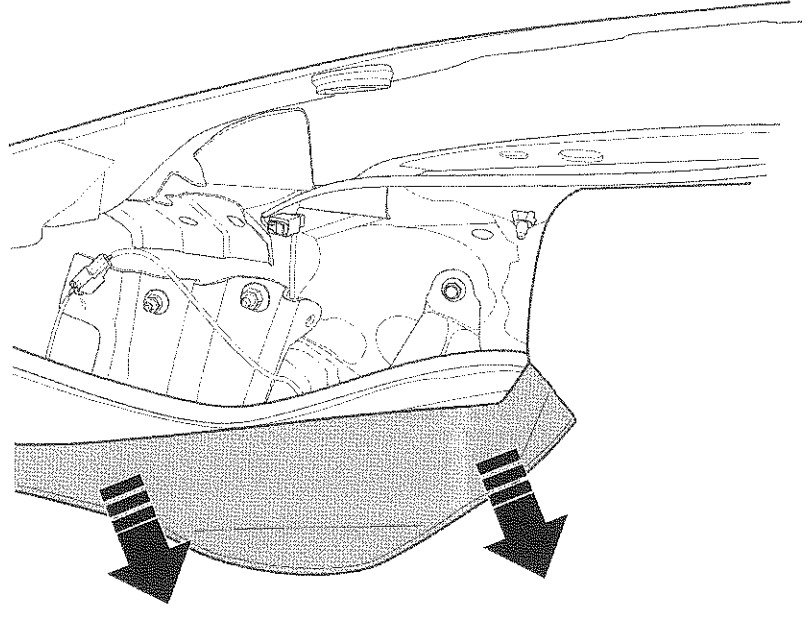
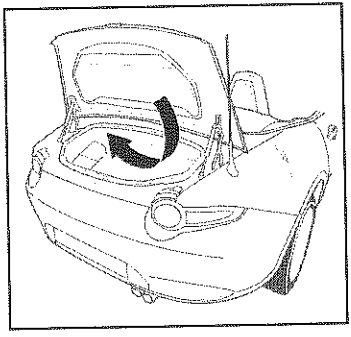

3

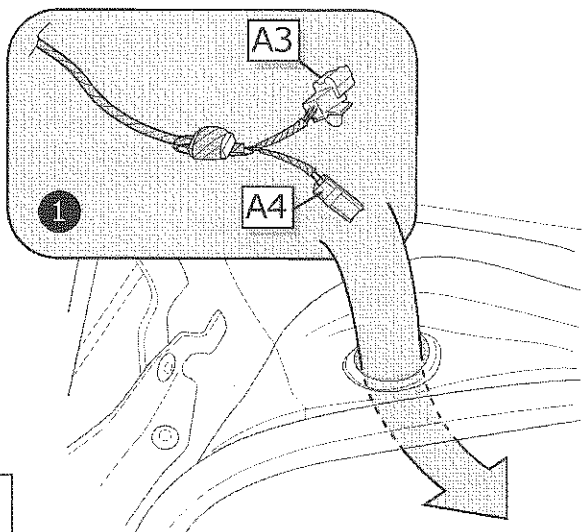
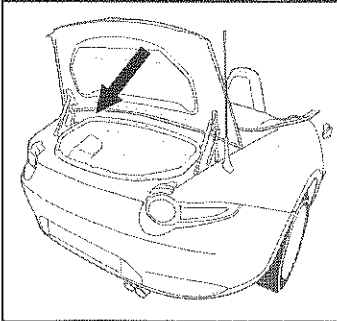

4

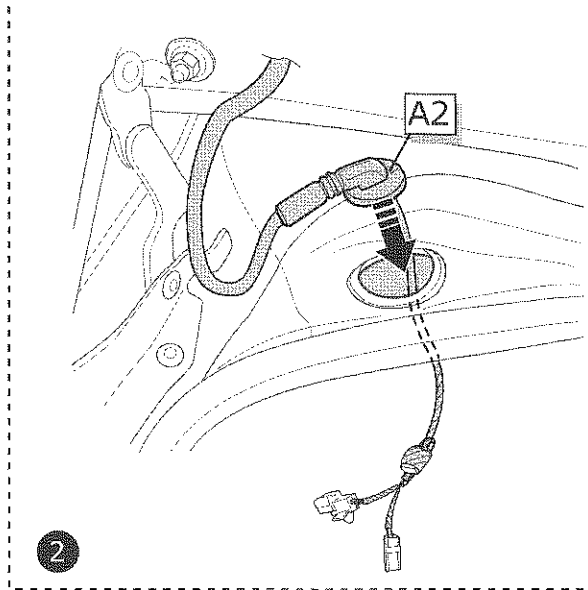

2

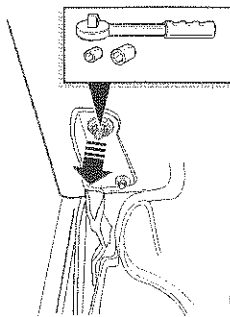
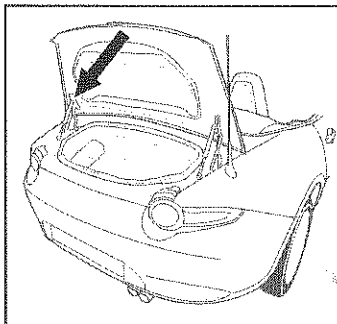

1

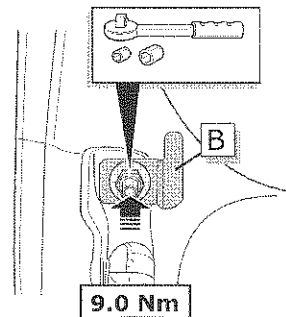

9.0 Nm

2

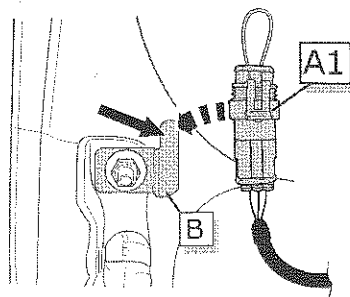

3

5

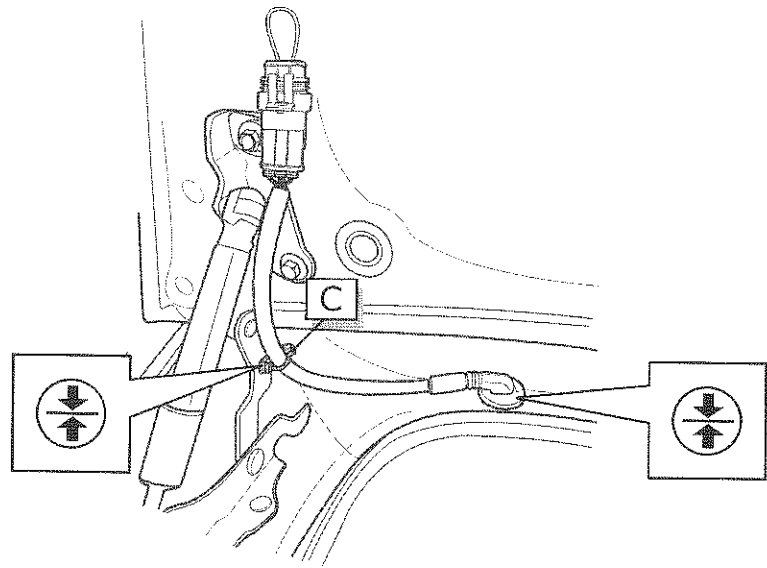
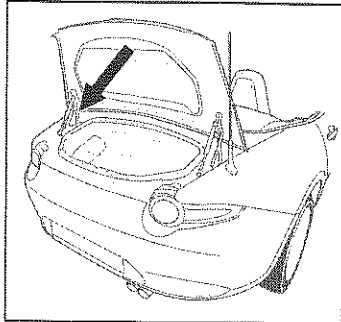

6

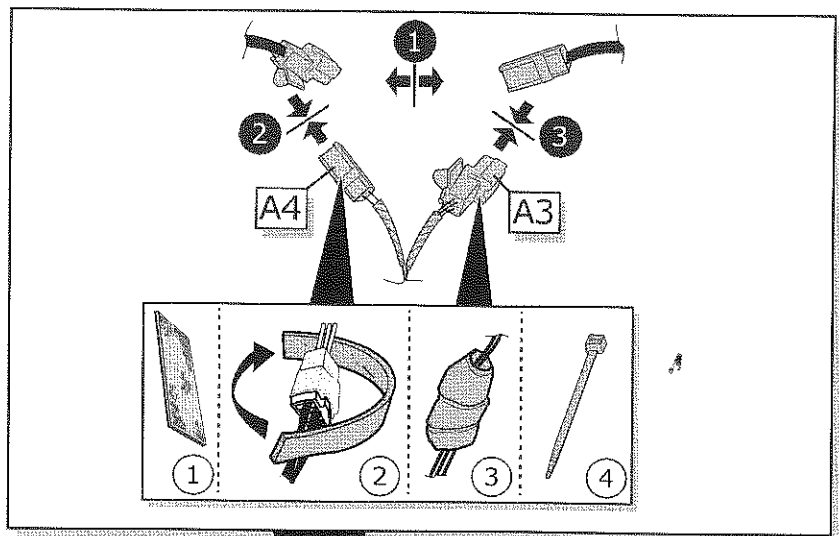
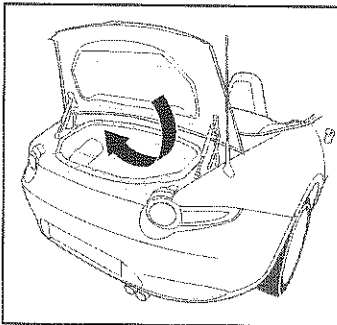

7

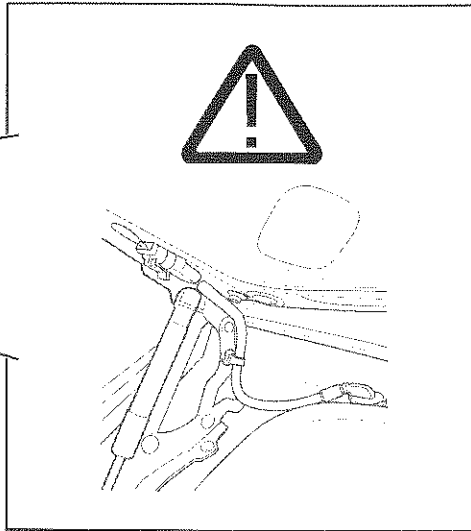
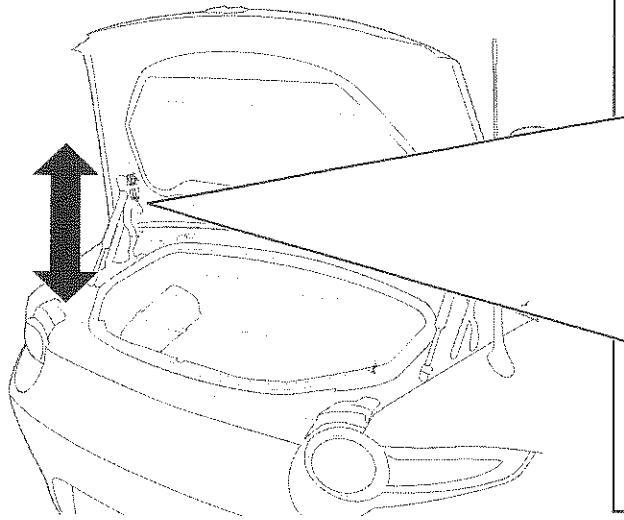

8

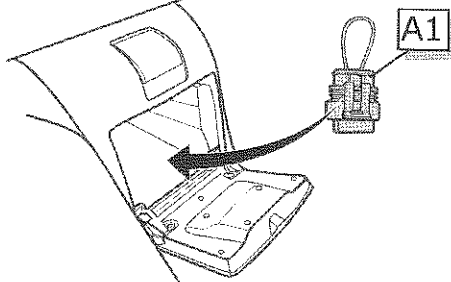
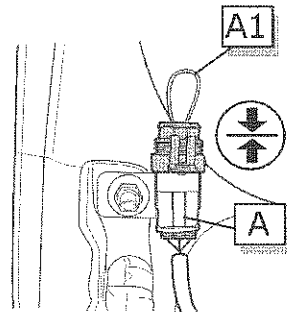
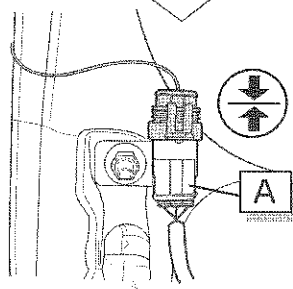
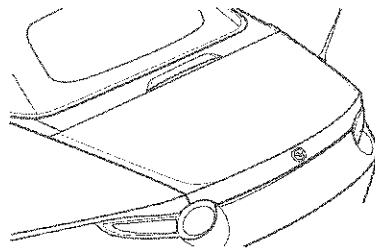
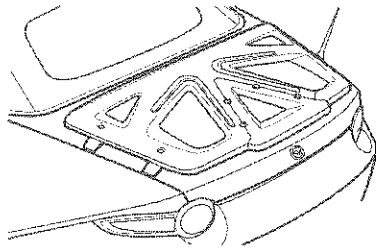

9

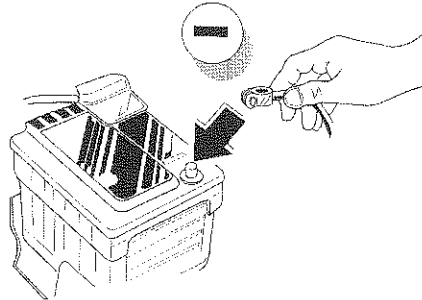
**10**

Subject to alteration without notice
Technische Änderungen vorbehalten
Reservadas modificaciones técnicas
Sous réserve de modifications techniques
Con riserva di apportare modifiche tecniche
Reservamo-nos o direito a alterações técnicas
Technische wijzigingen voorbehouden
Med forbehold for tekniske índringer
Tekniske forendringer forbeholdes
Med reservation för tekniska ändringar
Tekniset muutokset pidätetään
Technické zmeny vyhrazeny
A változtatások technika jogát fenntartjuk
Zmiany techniczne zastrzeżone
Επιφυλασσόμεθα για αλλαγές